

Zawiasa oparcia z zapadką

- prawa / lewa

3-taktowa

Nr 611.034 / 134

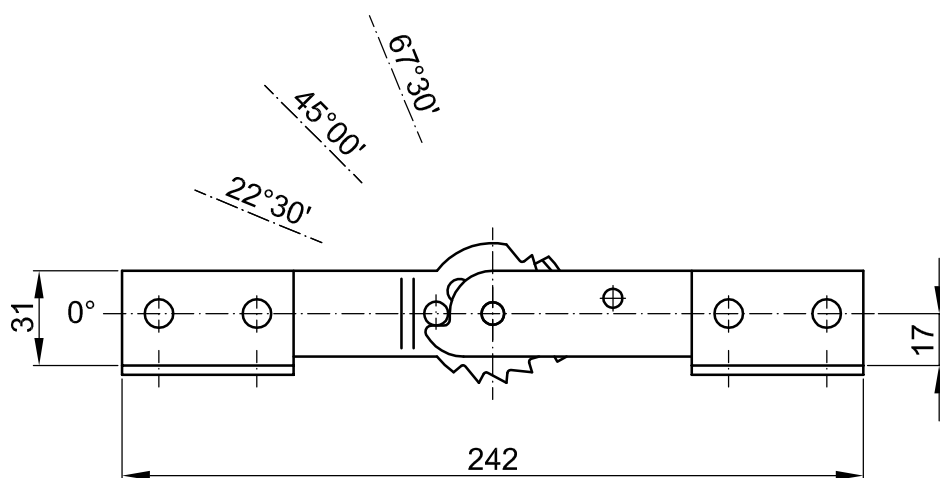

Mocowanie:
- 2x2 otwory $\varnothing 6,3$

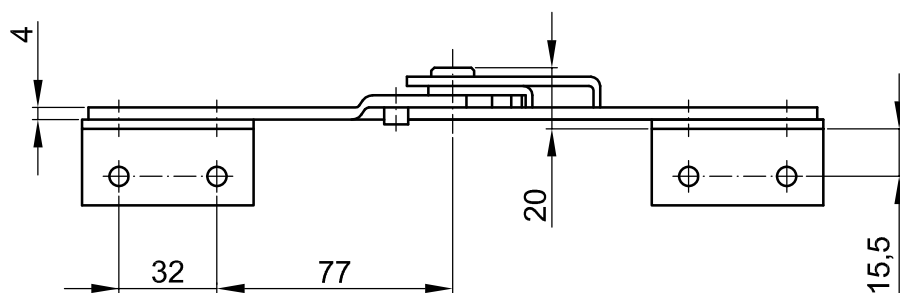

Powłoka:
- Cynkowana

