

Zawiasa oparcia z zapadką

- prawa / lewa

2-taktowa

Nr 611.033 / 133

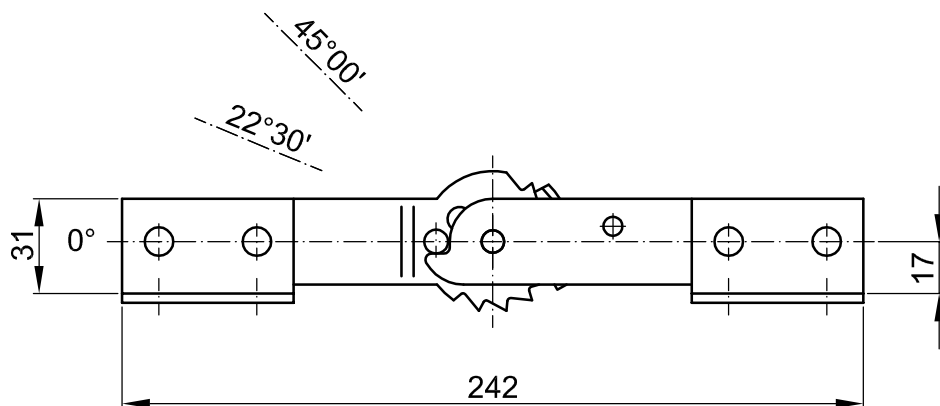

Mocowanie:
- 2x2 otwory $\varnothing 6,3$

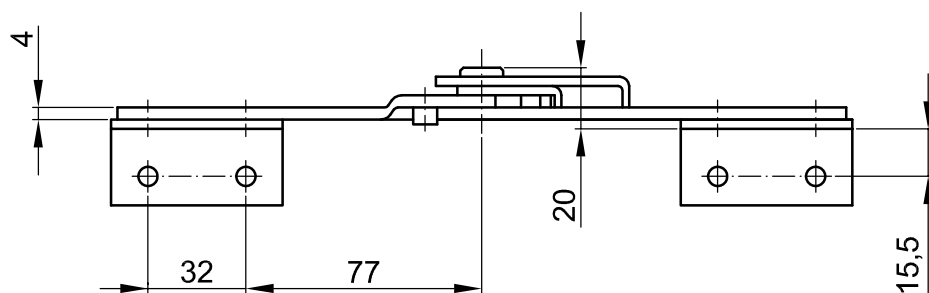

Powłoka:
- Cynkowana

