

Zawiasa oparcia z zapadką

- prawa / lewa

3-taktowa

Nr 611.032 / 132

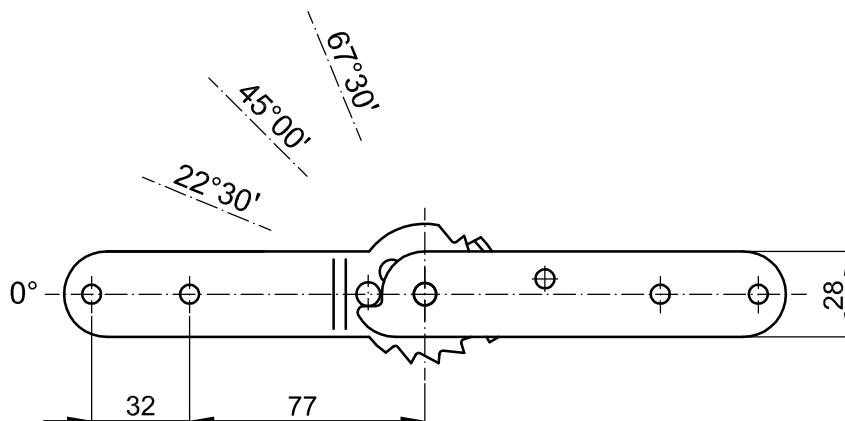

Mocowanie:

- 2x2 otwory $\varnothing 6,2$

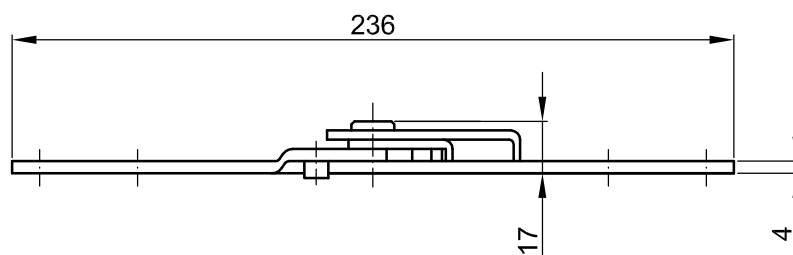

Powłoka:

- Cynkowana

