

Zawiasa oparcia z zapadką

- prawa / lewa

2-taktowa

Nr 611.013 / 113

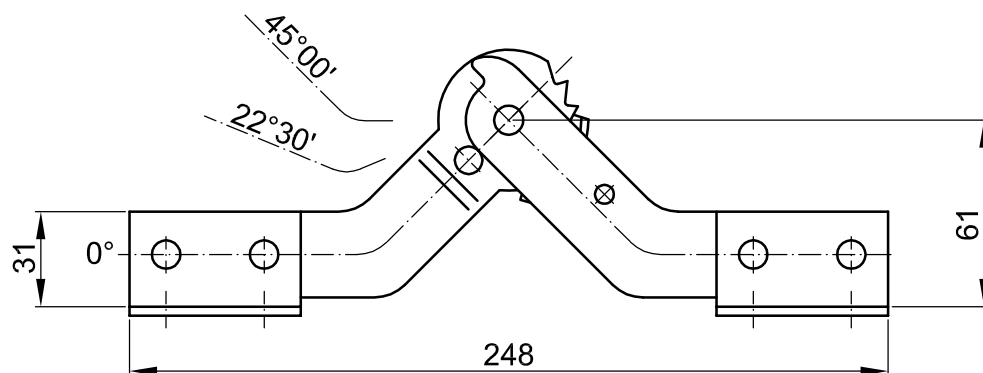

Mocowanie:
- 2x2 otwory $\varnothing 6,3$

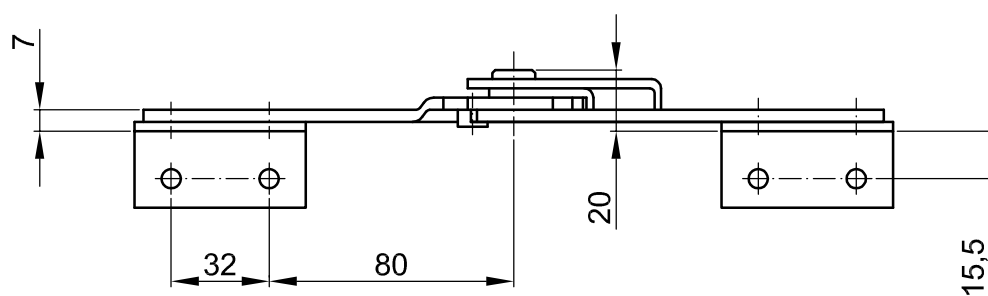

Powłoka:
- Cynkowana

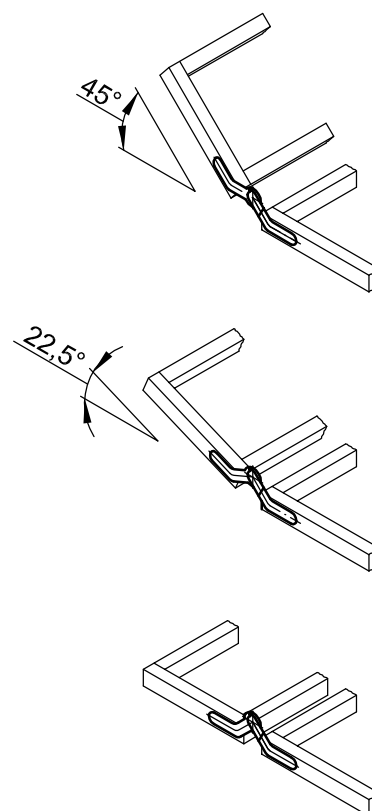
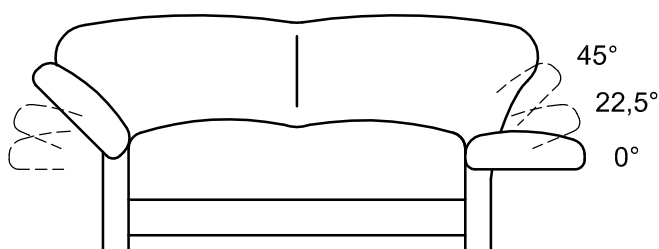

P.P.-H. "SŁAWPOL" Sp. z o.o.
85-731 Bydgoszcz; Polska
ul. Toruńska 145B
tel. *48 (52) 346-41-76;
tel./fax *48 (52) 372-62-05